



1. General information

- Optical presence detector for ceiling installation
- KNX Data Secure
- Rectangular detection area with up to 6 detection zones (Total area 11 x 15.5 m | 171 m²; at 4.5 m installation height)
- Automatic presence and brightness-dependent control for lighting and HVAC
- Each detection zone has its own light measurement
- Integrated temperature sensor
- **6 channels light, Z1 light – Z6 light:**
 - Switching or constant lighting control with 6 independent control systems and standby function (orientation light)
 - Switching mode with dimmable lighting
 - Free switch object with configuration type switching
 - Fully or semi-automatic device function
 - Brightness switching value configurable in lux by using parameters and telegram
 - Light time delay configurable by using parameters
 - Aura effect function
 - Manual override by telegram
- **6 channels HVAC, Z1 HVAC – Z6 HVAC:**
 - Configurable switch-on delay and time delay
 - Sending of operating mode
 - Separate block telegram
- **6 channels room occupancy, Z1 – Z6 room occupancy:**
 - Output of number of persons
 - Control of a fan with various stages
 - 3 configurable thresholds (threshold switch)
- The thePixa Plug app (for Android, iOS) allows settings via mobile devices
- Restriction of the detection area via thePixa Plug
- Adjustment of brightness measurements via thePixa Plug
- Test mode for checking function and detection area via thePixa Plug
- Optional accessories for surface mounting: 9070816
- The ETS (Engineering Tool) can be used to select application programmes, to assign specific parameters and addresses, and to transfer them to the device. www.theben.de
- Please refer to the KNX manual for detailed function descriptions.

2. Safety



Assembly and installation should only be carried out by a qualified electrician, somebody who has completed appropriate professional training and has the knowledge and experience necessary to be able to recognise and avoid the potential dangers posed by electricity.



Before installation/disassembly, disconnect the power supply and ensure that the parts are no longer live.



Prior to commissioning and using the product, read and observe all the operating instructions.

3. Proper use

- thePixa P360 KNX UP WH is an optical presence detector, which uses pixel-based technology. It does not resolve sharp images, does not recognize people and works in compliance with data protection regulations. thePixa uses image comparisons to detect differences in the status of monitored rooms.
- The device is intended for ceiling installation and is used in offices, conference rooms, corridors, schools, etc.
- Intended for interior installation only

4. Connection

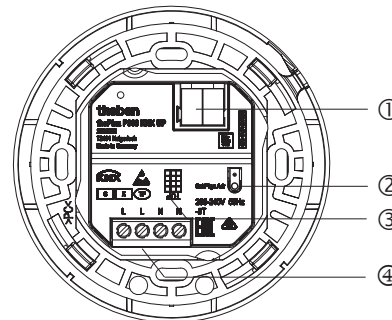

- ① Bus terminal KNX: Ensure correct polarity.
- ② Programming button and LED for physical address

⚠ Do not press the button when mains voltage is applied.

- ③ Positioning of the detector (see TOP)
 - ⓘ Observe zone alignment in the ETS.
- ④ Mains voltage

Connecting the presence detector

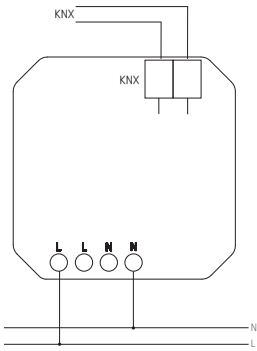

⚠ Secure device with an upstream type B or type C circuit breaker (EN 60898-1) with a maximum of 16 A.

⚠ Risk of electric shock!
The device does not have basic insulation around the terminals!

- Protect against accidental contact during installation.
- Maintain a minimum distance of 3 mm from live parts or use additional insulation, e.g. separating strips/walls.

⚠ Do not connect mains voltage (230 V) or other external voltages to the extension inputs!
Failure to comply with this instruction may result in death or serious injury!

⚠ During installation, ensure there is adequate insulation between mains voltage (230 V) and bus or extensions (min. 5.5 mm).

- Disconnect power source.

5. Installation and detection area

There are 3 ways to mount the presence detector at the ceiling:

- Flush mounting
- Ceiling installation
- Surface mounting

- ① Observe the recommended installation height of 2.5 m – 4.5 m!
- ① When installing several devices, keep a minimum distance of 2 m!

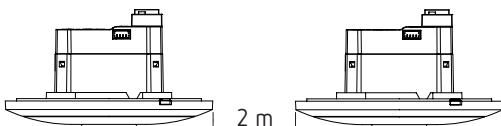

① Ensure a sufficiently large field of vision so that motion and the presence of people will be correctly detected.

① Avoid suspended lamps or partition walls, etc.

Flush-mounted installation

with a standard flush-mounting box, size 1 (installation opening Ø 60 mm, max. installation depth 37.5 mm)

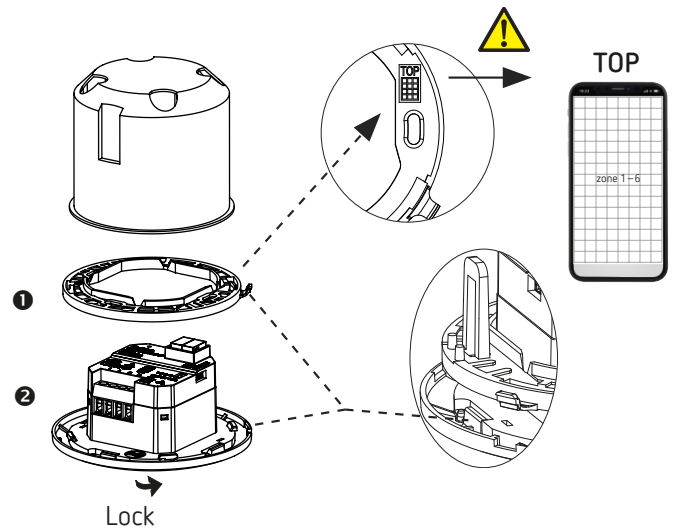

Ceiling installation

with a ceiling installation box 9070992 (installation diameter 68 mm).

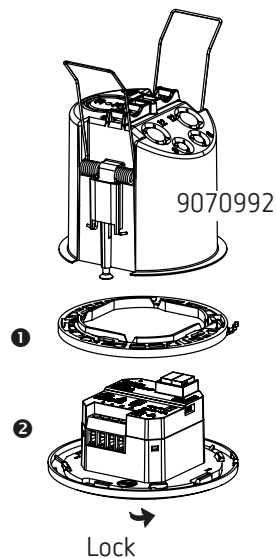

Surface mounting

For surface mounting, an optional accessory 9070816 is available.

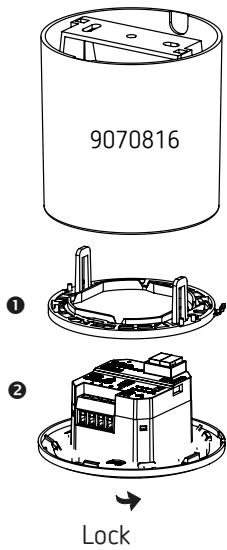

Dismounting

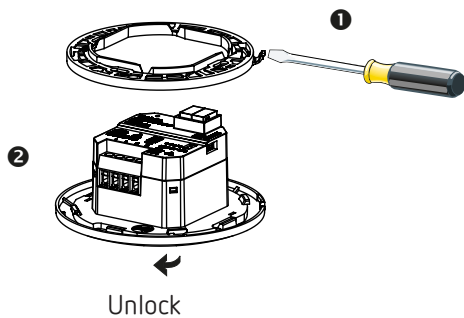

Detection area

The rectangular detection area of the presence detector covers a large area and can be divided into 6 independent zones.

- ① The 6 zones can be positioned either in the ETS, or via the thePixa Plug app. In the app, each zone can then be adjusted individually.

⚠ If the zones are entered via the ETS, it is imperative to observe the orientation of the presence detector when installing it.

Installation height	Detection area walking	Detection area seated
2.5 m	54 m ² 6.0 m x 9.0 m	22 m ² 4.0 m x 5.5 m
3.0 m	79 m ² 7.5 m x 10.5 m	35 m ² 5.0 m x 7.0 m
3.5 m	102 m ² 8.5 m x 12.0 m	51 m ² 6.0 m x 8.5 m
4.0 m	128 m ² 9.5 m x 13.5 m	79 m ² 7.5 m x 10.5 m
4.5 m	171 m ² 11.0 m x 15.5 m	102 m ² 8.5 m x 12.0 m

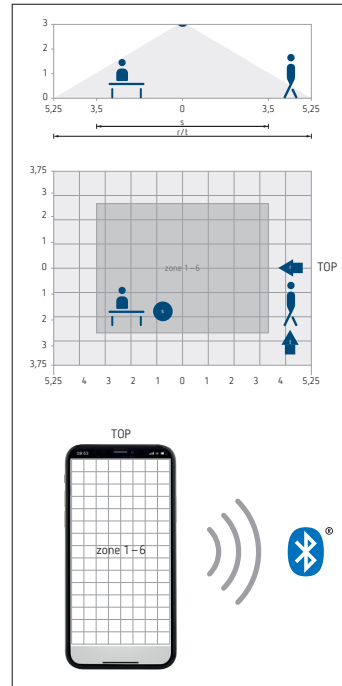

- ① The designation **TOP** indicates the orientation of the detection area.
- ① Detection with night mode activated: Night mode switches on automatically at low surrounding brightness. In this mode, the detection area may be limited at a installation height of ≥ 4 m, depending on the application.

Brightness measurement

The presence detector measures the brightness of the entire area in each zone. The measured brightness is the average value of this area measurement.

- ① Direct incidence of light on the presence detector influences the brightness measurement.
- ① Avoid placing floor lamps or suspended lighting in the detection area.
- ① For each zone, the current brightness has to be taught in with the smartphone/tablet (see chapter 4. Parameters, page 7.)

Constant lighting control

The zones must be arranged in such a way that each individual zone only captures its own artificial light. Artificial light controlled by other zones, or manually switched working lights, will affect the brightness measurement of the detector.

- ① Avoid direct artificial light.

Switching mode

If the brightness measurement is deactivated, the lighting is only switched depending on presence.

6. Functions

Light

The optical presence detector switches or controls 6 lighting groups depending on the presence of persons and the current brightness. The brightness switching value or setpoint is set via parameters or objects (with objects only brightness setpoint).

Switching

The lighting is switched on when there is presence and low brightness, and switched off when there is absence or sufficient brightness. A button can be used to manually switch or dim, which stops the control for the duration of the presence. In addition, a free switch object is available.

Constant lighting control

When constant lighting control is active, the brightness is held constant at the brightness setpoint value. The control is started fully automatically or manually via button. Manual switching off or dimming stop the control for as long as the presence continues.

Standby

The standby function serves as an additional delay after the motion time delay has elapsed. The lighting will be set to the standby dimming value (1 – 25%) at the end of the time delay. The standby time can be set between 1 s and 60 min or permanently. The lighting is switched off if the brightness level in the room exceeds the brightness switching value/ setpoint. If the brightness level in the room falls below the brightness switching value/ setpoint, the lighting will be switched on at the standby dimming value. The standby function can be activated or blocked via an object.

Button control

The lighting can be manually switched or dimmed any time via a button. If the light is switched on manually, it will remain on during switching mode for at least 30 minutes, provided people are present. Afterwards, it will be switched off if the brightness is sufficient. If the room is abandoned (before), the light goes out after the set time delay. With constant lighting control, the lighting is switched on and the control is activated. If the artificial light is switched off manually, the lighting remains off as long as people are present. At the end of the time delay, the lighting will switch automatically again.

Fully or semi-automatic

The lighting control is either fully or semi-automatic. As a "fully automatic device", the lighting is switched on and off. As a "semi-automatic device", the lighting must always be switched on manually. The lighting is switched off automatically.

Aura effect

The light accompanies the user to the area where he is at the moment. The surrounding areas are dimmed to a set orientation light value.

HVAC

For each detection zone (max. 6 zones) the presence information can be transmitted, e.g. for heating, ventilation or air conditioning control. Each channel has a switch-on delay and a time delay. The integrated temperature sensor also measures the ambient temperature and can be used for control purposes.

Switch-on delay

The switch-on delay prevents instantaneous switching on. The telegram is sent only on expiry of the switch-on delay, provided that people are present for this time.

Time delay

The time delay allows a delayed switching off of HVAC devices and systems after the room has been left.

Room occupancy

In each detection zone (max. 6 zones), persons can be detected, which allows for anticipatory control, depending on the number of persons. The predefined 3 thresholds can be used to control a fan, for example. Corresponding links can be used to add up the number of persons from different zones.

Threshold switch

The 3 integrated threshold switches allow step-by-step control, such as the control of a fan.

Visual statistics/evaluations

With the Pixa Plug app, heat maps as well as occupancy statistics can be displayed graphically and time-controlled. The heat maps can be exported via a .csv file. The information on occupancy statistics can also be called up via telegrams.

7. Start-up

Settings

- ① Basic settings are made via the ETS (see application description in the KNX manual).
- ① The presence detector supports KNX Data Secure.

For final start-up, the Pixa Plug app is available. The BLE module integrated in the presence detector allows many functions to be called up or used directly with a smartphone or tablet, such as creating a background image, editing zones, calibrating brightness measurements, displaying statistics, etc. In addition, each brightness measurement as well as the integrated temperature measurement can be taught in. The control commands can be used to change the behaviour during operation.

- ① During start-up, the steps on page 5 "IMPORTANT ..." must be carried out.

Programming mode

Programming mode can be activated either with the programming button on the back of the presence detector or by using thePixa Plug app (without dismantling the detector). An activated programming mode is indicated by the illuminated LED on the programming button.

Resetting the presence detector to the factory setting

The presence detector is delivered with a factory setting that can be restored at any time.

Activate	Description
Power up	Hold down the programming button when the bus voltage is switched on.

Switch-on behaviour

After connecting the bus voltage or downloading the parameters via the ETS, the detector is ready for operation after approx. 1 s.

- ① Mains voltage must be available.

8. Settings via thePixa Plug app

Connecting the presence detector with a mobile device and thePixa Plug app

The presence detector can be controlled via Bluetooth using the app. The smartphone or tablet will be connected to the presence detector via the integrated Bluetooth module.

- Download **thePixa Plug** app from the App Store or Google Play Store.



- Open **thePixa Plug** app and press + in the menu bar.
→ The device list of available devices appears.
- Select the device and confirm with OK.



- If the smartphone/tablet is connected with the presence detector, the LED on the front of the presence detector lights up green.
- Access to the detector can be protected with a password (✎).
- If the password is no longer in your possession, follow the instructions for **resetting the password**.

IMPORTANT: The following must be observed during start-up ...

- Create a background image with 📷.
- Add or edit zones.
- Enter or check the following parameters:
 - Perform temperature calibration (if necessary)
 - **Perform brightness calibration for each zone!**
 - If necessary, adjust installation height, sensor sensitivity and room definition.

Overview

Menu navigation is via a slider located in the upper area of the screen:

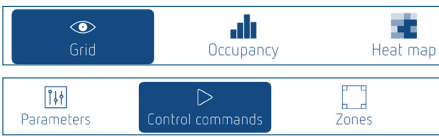

Grid – occupancy – heat map – parameters – control commands – zones

1. Grid

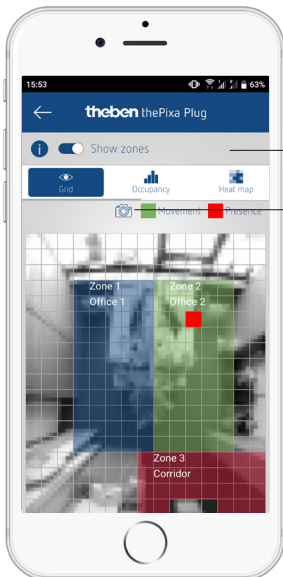
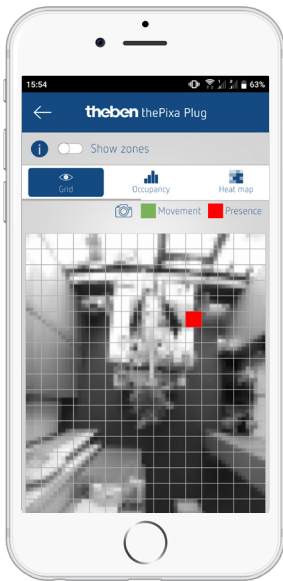

Show and hide zones

Create a (new) background image

The motion/presence detected by the presence detector is displayed in green (motion) and red (presence).

- ① Various algorithms are stored in the presence detector for different types of changes. This can lead to a motion/presence being displayed for a short time longer than it actually exists. This means that those objects are displayed that are also forwarded to the KNX unit.

2. Occupancy

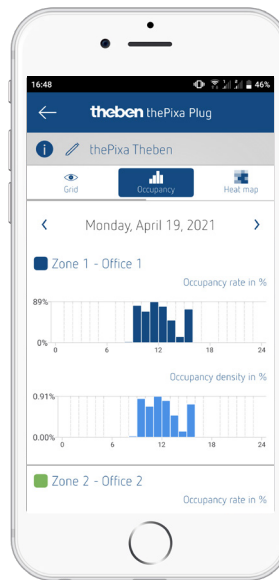

Graphical display of occupancy rate and occupancy density of the past 7 days, for each zone individually:

- Occupancy rate: zone occupancy per hour in %
- Occupancy density: zone utilisation per hour in %

3. Heat map ("thermal image")



Show and hide zones

Detail settings/export/delete

Selection of stored heat maps

- Graphical display of the recorded motions over a defined period of time. (export as a .csv file possible).
- Up to 24 heat maps can be stored and called up.

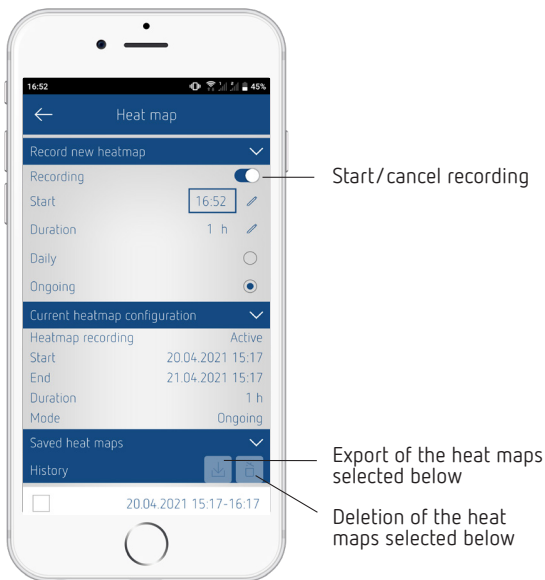

Detail settings for the heat maps

- ① A maximum of 24 heat maps are stored. After that, the recording is automatically interrupted.

4. Parameters

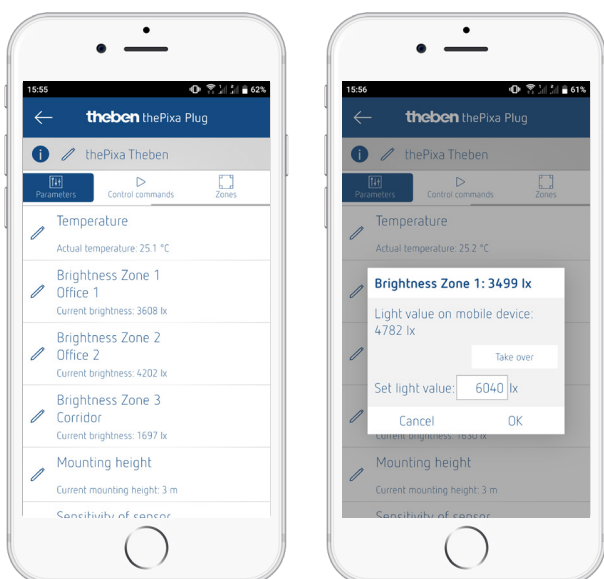

Temperature

- Display of the currently measured temperature.
- The measured value can be corrected by entering a new actual temperature.

- ① Before the temperature calibration can be carried out, the presence detector must be in operation for at least 30 minutes.

Brightness zone x

- Display of the currently measured brightness.
- The measured value can be corrected by entering a new light value.

- ① Perform the calibration at the desired surrounding brightness.

You must proceed as follows ...

- Select parameter <brightness zone X>.

→ Pop-up window opens.

- Place the smartphone or tablet in the corresponding zone.
- Select the **Apply** button.
 - Measured lux value (from smartphone/tablet) is entered in the field <set light level value>.
- Go out of the zone.
- Finally, press the **OK** button.

- ① The brightness calibration must be carried out for each zone.
- ① Instead of the brightness value of smartphones/tablets, a lux value (measured by a luxmeter) can also be entered manually.
- ① If the local conditions change considerably, the brightness has to be recalibrated.
- ① If the smartphone/tablet does not have an integrated brightness sensor, it will be indicated by an error message. Manual calibration with an external lux meter can still be carried out.

Installation height

- Selection of installation height of detector
- Selection of 2.5 – 4.5 m

Sensitivity of the detector

The detector has 5 sensitivity levels:

- 1 very insensitive
- 2 insensitive
- 3 standard
- 4 sensitive
- 5 very sensitive

- ① The sensitivity refers to all zones.

Room definition

Specification of the room in which the presence detector is used:

- Standard: Standard rooms such as office, corridor, etc.
- Meeting room: Der The detector is installed in a meeting room and thus adapted to the conditions of this room, with a focus on counting people.

- ① The room definition refers to all zones.

5. Control commands

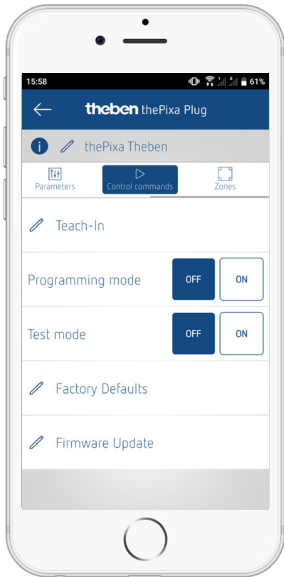

Teach-in

The currently measured brightness value will be accepted as the brightness setpoint value. It is possible to select which zones are to be taught in.

- ① If constant lighting control is activated in one zone, the taught-in brightness setpoint value is adopted for the <presence> status.

Programming mode

- Switching on and off
- Activated programming mode must always be deactivated manually.

Test mode

- When the test mode is activated, the number of persons to be simulated can be entered. A distinction is made between motion and presence.
- Each zone can be tested individually.

Factory settings

The presence detector is supplied with a factory setting. This factory setting can be restored at any time.

Firmware update

One can manually search for a firmware update.

- ① In general, the system automatically searches for the firmware update. If a new update is available, a pop-up window appears.

6. Zones



Create a (new) background image

Transfer zone configuration to another detector

Edit zones

Delete zones individually

Add exclusion zone

Add zone

- Add and edit 6 zones, which can be labelled.

- An exclusion zone can be added to each zone to suppress sources of interference.
- Zone configurations can also be transferred to other thePixa devices.

- ① When creating the zones, make sure that walls, windows and large screens are not in the zone. Exclusion zones can be included as an aid.

Info

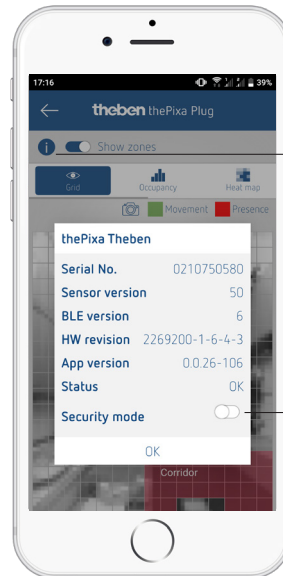

Info

Switch safety mode on/off

- List with information on hardware and software.
- In addition, the safety mode can be switched on and off.

- ① Activate safety mode: A password must be created in order to activate the mode. This password protects the following parameters or functions:
 - Entering actual temperature
 - Light level value per zone
 - Installation height
 - Detection sensitivity
 - Teach-in
 - Factory settings
 - Firmware update
 - Zone editing

- ① The safety password must consist of 6 characters: A-Z, 0-9.
- ① The safety mode as well as the safety password can also be activated or defined in the ETS application. The safety mode can be edited subsequently in the app.

9. Troubleshooting

Fault	Cause
Light does not switch on or switches off during presence and darkness	Lux value is set too low; detector set on semi-automatic; light was switched off manually via push button or with remote control; person not within detection area; obstruction(s) interrupting detection; time delay set too short.
Light is switched on in case of presence despite sufficient brightness	Lux value set too high; light was recently set manually by button (wait 30 min in switching mode); performing a firmware update.
Light is constantly switched on despite no one is present	Interruption of the mains voltage (230 V). After restoration of voltage, the detector is back in normal operation.
Light does not switch off, or light switches on spontaneously when no one is present	Wait for time delay to elapse (different time delays can be configured); optical sources of interference in the detection area: reflections of light influences, larger screens in the detection area, moving objects such as curtains when the window is open.
Smartphone/tablet cannot be connected with the detector	BLE not activated in the smartphone/tablet; interruption of the mains voltage (230 V).

10. Technical data

Operating voltage:	230 – 240 V AC
KNX bus voltage:	21 – 32 V DC
KNX bus power input:	< 10 mA
Frequency:	50 Hz
Power input (230 V):	Day mode 0.9 W; night mode 1.6 W
Minimum load:	10 mA
Brightness setting range:	5 – 3000 lux/ measurement off
Lighting time delay:	0 s – 60 min
Standby dimming value light:	1 – 25% of the dimming value
Standby time light:	0 s – 60 min/permanently on
HVAC switch-on delay:	0 s – 120 min
HVAC time delay:	0 s – 120 min
HVAC standby runtime:	0 s – 120 min
HVAC standby value:	0 – 255
KNX medium:	TP1-256
Protection rating:	IP 20 in accordance with EN 60529
Protection class:	II subject to designated installation
Operating temperature:	–5 °C ... +45 °C
Recommended installation height:	2.5 – 4.5 m (minimum height ≥ 2.5 m)
Detection angle:	360° horizontal

Detection area:	15.5 x 11 m 171 m ² moving radially/tangentially
Pollution degree:	2
Rated impulse voltage:	4 kV
Software:	Class A
Radio frequency/transmission power:	BLE 2.4 GHz Class 2 (2.5 mW)

Theben AG herewith declares that this type of radio installation complies with Directive 2014/53/EU. The complete text of the EU Declaration of Conformity is available at the following Internet address: www.theben.de/red-konformitaet

Cleaning and service

- Only use a dry, soft cloth to clean the device surface.
- Do not use any cleaning agents or solvents.

Disposal

- Dispose of device in environmentally sound manner (electronic waste).

11. Dimensional drawings

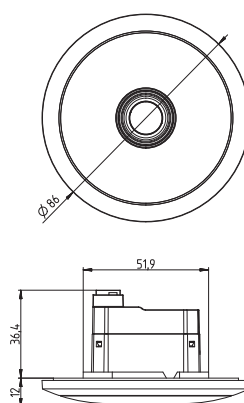

12. Open source software components (OSS)

A list of the open source components used can be found on the Internet at the following link: <https://www.theben.de/OSS>

13. Contact

Theben AG
 Hohenbergstr. 32
 72401 Haigerloch
 GERMANY
 Phone +49 7474 692-0
 Fax +49 7474 692-150

Hotline
 Phone +49 7474 692-369
hotline@theben.de

Addresses, telephone numbers, etc.
www.theben.de